

NEW

# Tarasola 2024

---

DE EN FR

# Tarasola Carport

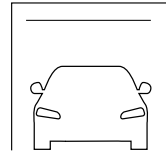

mit Polycarbonatdach | with Polycarbonate Roof | avec toit en polycarbonate

Konstruktion angepasst für die Installation eines Wirtschaftsraums  
| Construction Adapted for Attaching a Storage Room  
| Construction adaptée à l'installation d'un espace de rangement



Der Carport mit Polycarbonatdach ist die ideale Lösung, die nicht nur das Auto effektiv vor Witterungseinflüssen schützt, sondern auch den Zugang zu natürlichem Sonnenlicht ermöglicht und gleichzeitig vor UV-Strahlung schützt. Die Ausstattung des Carports mit einem Wirtschaftsraum erhöht zusätzlich seine Funktionalität und ermöglicht die Lagerung von Werkzeugen, Gartengeräten, Fahrrädern und Autozubehör.

A carport with a polycarbonate roof is the perfect solution that not only effectively protects the car from weather conditions but also provides access to natural sunlight while protecting against UV radiation. Equipping the carport with a storage room enhances its functionality, allowing for the storage of tools, garden equipment, bicycles, or car accessories.

Le carport avec un toit en polycarbonate est une solution idéale qui protège efficacement la voiture des conditions météorologiques. Il offre un accès à la lumière naturelle du soleil, tout en protégeant contre les rayons UV. L'équipement d'un espace de rangement au carport augmente également sa fonctionnalité en permettant le stockage d'outils, d'équipements de jardin, de vélos et d'accessoires automobiles.

# Hauptmerkmale | Key features | Caractéristiques principales

- Schutz vor Witterungseinflüssen und UV-Strahlung
- Zugang zu natürlichem Sonnenlicht
- Anpassbare Größe nach individuellen Bedürfnissen
- Die Integration des Wirtschaftsraums in die Form des Carports ermöglicht die Aufrechterhaltung der Ästhetik der Hausumgebung
- Protection against weather conditions and UV radiation
- Access to natural sunlight
- Size Adjustable to individual needs
- Integrating the storage room into the carport structure allows for maintaining the aesthetic appeal of the home environment
- Protection contre les conditions météorologiques et les rayons UV
- Accès à la lumière naturelle du soleil
- Possibilité d'adapter la taille selon les besoins individuels
- L'intégration de l'espace de rangement dans la structure du carport permet de maintenir l'esthétique de l'environnement de la maison

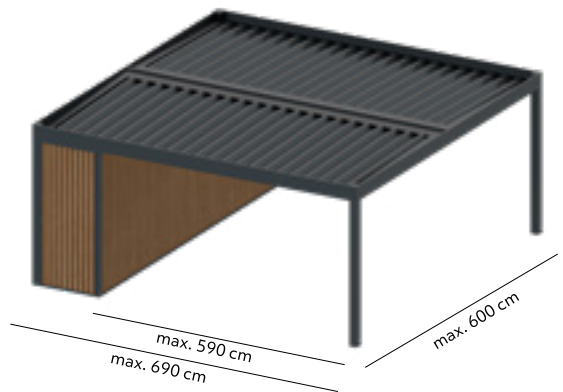
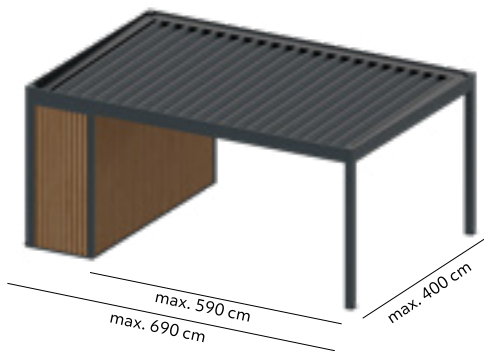

Einzelcarport  
| One-station Carport | Carport à station unique

Doppelcarport  
| Two-stations Carport | Carport à deux stations



Tür zum Hauswirtschaftsraum  
| Door to utility room  
| Porte à local technique de rangement

Flügeltüren  
Rechts/Links  
Schwellenfreie Türen  
Festes Maß 90x200 cm  
Türaufbau: Höhe an Durchgang angepasst  
Öffnung nach innen/außen  
Schließung: Zylinderschloss

Hinged doors  
Right/Left  
Threshold-free doors  
Fixed dimension 90x200 cm  
Door extension: height adjusted to the clearance  
Opening inwards/outwards  
Closure: lock with insert

Porte battante  
Droite/Gauche  
Porte sans seuil  
Dimension fixe 90x200 cm  
Superstructure de la porte : hauteur adaptée à l'espace libre  
Ouverture vers l'intérieur/extérieur  
Fermeture: verrou avec insert

# Tarasola Fix

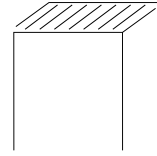

mit Polycarbonatdach | with Polycarbonate Roof | avec toit en polycarbonate

Konstruktion angepasst für die Installation eines Glasdachs  
| Construction Adapted for Glass Roof Installation  
| Construction adaptée à l'installation d'un toit en verre



Tarasola Fix ist eine Überdachung, die einen konstanten Zugang zu Sonnenlicht gewährleistet. Das Dach aus Polycarbonat zeichnet sich durch hohe Lichtdurchlässigkeit, thermische Isolierung und Schutz vor UV-Strahlung aus. Der Rahmen der Konstruktion ist auch für die Montage eines Glasdaches geeignet. Das transparente Dach verleiht dem Raum eine helle, optisch vergrößerte und offener wirkende Atmosphäre.

Tarasola Fix is a roofing that guarantees a constant sunlight inflow. The polycarbonate roof is characterized by high light permeability, thermal insulation, and protection against UV radiation. The frame of the structure is also adapted for the installation of a glass roof. The transparent roof makes the space brighter, visually enlarged, and gives it a more open character.

Le Tarasola Fix est une couverture qui garantit un flux constant de lumière solaire. Le toit en polycarbonate se caractérise par une grande perméabilité à la lumière, une isolation thermique et une protection contre les rayons UV. Le châssis de la construction est également adapté à l'installation d'un toit en verre. Le toit transparent rend l'espace plus lumineux, optiquement agrandi et lui confère un caractère plus ouvert.

# Hauptmerkmale | Key features | Caractéristiques principales

- Optischer Vergrößerungseffekt des Raums
- Ermöglicht das Eindringen von natürlichem Licht und hält die Helligkeit und Wärme im Raum aufrecht, ohne übermäßige Erwärmung
- Wetterbeständigkeit
- Bietet Anpassungs- und Dekorationsmöglichkeiten und ermöglicht die Anpassung des Aussehens an individuelle Bedürfnisse und die Ästhetik des Raums
- Optical enlargement effect of the space
- Provides penetration of natural light, maintaining brightness and warmth in the room without excessive heating
- Resistance to weather conditions
- Offers customization and decoration possibilities, allowing for adjusting the appearance to individual needs and the aesthetics of the space
- Effet d'agrandissement optique de l'espace
- Assure la pénétration de la lumière naturelle, maintenant la luminosité et la chaleur dans la pièce sans surchauffe excessive
- Résistance aux conditions atmosphériques
- Offre des possibilités de personnalisation et de décoration, permettant d'ajuster l'apparence aux besoins individuels et à l'esthétique de l'espace.

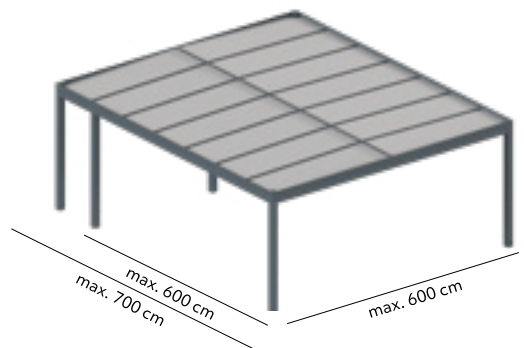
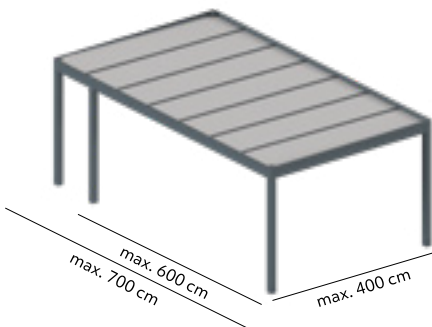

Einseitigen Pultdach  
| Single-pitched roof | Toit à une pente

Zweifach geneigten Dach  
| Double-pitched roof | Toit à deux pentes

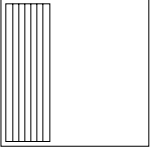

Fester Wandpanel / Fester Deckenpanel  
| Fixed Wall Panel / Fixed Ceiling Panel  
| Panneau fixe mural / Panneau fixe de plafond



Das feste Wandpanel ist ein vielseitiges Produkt, das sowohl als teilweise als auch als vollständige Verkleidung für die Wände einer Konstruktion verwendet werden kann. Dasselbe Panel kann auch auf dem Dach unter Polycarbonat/Glas montiert werden. Seine Hauptaufgabe besteht darin, vor intensivem Sonnenlicht, Wind und Regen zu schützen. Es bietet teilweisen Schatten, was besonders wichtig ist, wenn das transparente Dach sich in der Sonne erwärmt. Das Panel erzeugt einen einzigartigen visuellen Effekt, insbesondere in Kombination mit LED-Beleuchtung.

The fixed wall panel is a versatile product that can be used both as partial and complete enclosure for the construction walls. The same panel can be installed on the roof under polycarbonate/glass. It's main purpose is to provide protection against intense sunlight, wind, and rain. It offers partial shading, which is particularly important in areas where a transparent roof can heat up in the sun. The panel creates a unique visual effect, especially when combined with LED lighting.

Le panneau fixe mural est un produit polyvalent qui peut être utilisé aussi bien comme revêtement partiel que complet pour les murs d'une structure. Ce même panneau peut également être monté sur le toit sous du polycarbonate/verre. Sa principale fonction est de protéger contre l'intensité du soleil, le vent et la pluie. Il offre une ombre partielle, ce qui est particulièrement important dans les endroits où un toit transparent peut chauffer au soleil. Le panneau crée un effet visuel unique, surtout lorsqu'il est combiné avec un éclairage LED.

# Hauptmerkmale | Key features | Caractéristiques principales

- Kann als teilweise oder vollständige Seitenverkleidung und Deckenpaneel verwendet werden
- Hergestellt aus hochwertigem Aluminium
- Erhältlich in einer breiten Palette von RAL-Farben oder holzähnlichen Ausführungen
- Bietet Schutz vor intensivem Sonnenlicht, Wind und Regen
- Ist pflegeleicht und erfordert keine zeitaufwändige Wartung
- Can be used as partial or complete side enclosure and ceiling panel
- Made of high-quality aluminum
- Available in a wide range of RAL colors or wood-like finishes
- Provides protection against intense sunlight, wind, and rain
- Easy to maintain, no time-consuming maintenance
- Peut être utilisé comme revêtement partiel ou complet pour les côtés et le plafond
- Fabriqué en aluminium de haute qualité
- Disponible dans une large gamme de couleurs RAL ou dans des finitions similaires au bois
- Assure une protection contre l'intensité du soleil, le vent et la pluie
- Facile à entretenir, ne nécessite pas d'entretien chronophage



Standard | Standard | Standard

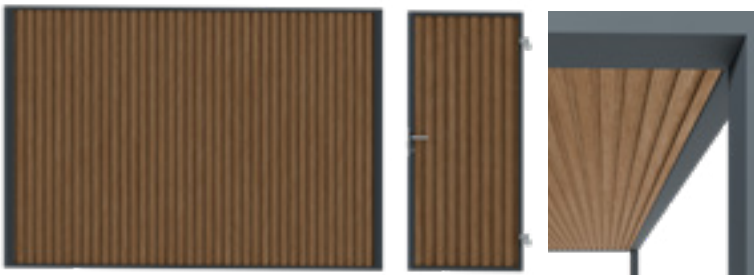

Zusätzlich | Additional  
| Couleurs supplémentaires



## Fester Wandpaneel | Fixed wall panel | Panneau mural fixe



# Tarasola®



## Tarasola Carport Tarasola Fix

DE EN

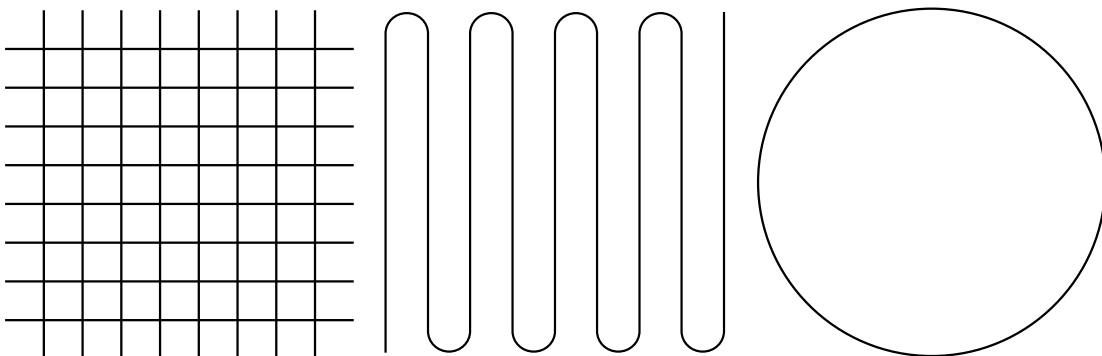





# Inhaltsverzeichnis

## Table of contents

- 02 **Produktbeschreibung** | Product description
- 04 **Bildergalerie** | Photo gallery
- 20 **Haupteigenschaften** | Key features
- 21 **Querschnitten** | Cross-sections
- 22 **Moduls und Maximale Abmessung** | Models and maximum dimensions
- 25 **JUICEBOX PRO AUTOLADESTATION**  
| Car Charging Station Juicebox Pro
- 26 **Photovoltaikanlage** | Photovoltaic panels
- 28 **Seitliche Ausstattung** | Side development
- 29 **Zubehör** | Accessories
- 30 **Farbpalette** | Colour range
- 32 **Zertifikate** | Certificates
- 32 **Auszeichnungen** | Awards

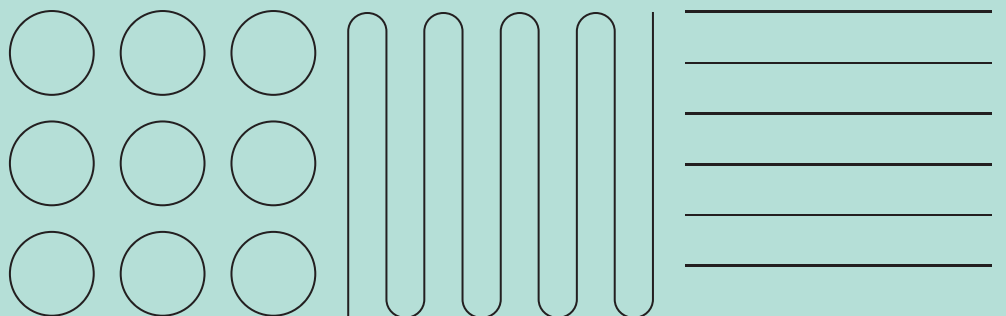

# Produktbeschreibung

## Product description

DE

**Tarasola Carport** ist ein modernes Garagenvordach. Es ist ein solides, festes Dach, das das Auto vor Witterung, also vor Sonne, Regen, Wind und Schnee schützt. Eine ästhetische Form ohne sichtbare Verbindungen und eine große Farbauswahl, die es Ihnen ermöglicht, Carport an jede Umgebung anzupassen.

### **Tarasola Carport = Tarasola Fix**

Die Carport-Konstruktion kann erfolgreich als eine Terrassenüberdachung dienen. Dank dieser modernen Innovation können Sie die Terrassenüberdachung optional mit einem schönen Dachunterstoff und sogar mit einer LED-Streifen-Beleuchtung und einem Infrarot - Heizstrahler ausstatten.

Wenn Sie sich selbst, Ihre Gartenmöbel und weitere Ausstattung vor schlechten Witterungsbedingungen schützen möchten, lohnt es sich, Shutters, ZIP-SCREENS oder Verglasungen zu wählen. Sie erhalten einen funktionalen Raum zum Zeitverbringen zu jeder Tageszeit oder Jahreszeit.

EN

**The Tarasola Carport** is a modern parking space. It is a solid, fixed roofing that protects your car from the sun, rain, wind and snow. The minimalist form, aesthetically pleasing finish, with no visible fixings and a choice of colours allows the Carport to fit into any environment.

### **Tarasola Carport = Tarasola Fix**

The carport structure can be successfully used as a standard terrace roofing. In this option, we recommend adding a lower roof in the form of an aesthetically pleasing fabric and equipping the structure with LED lighting and infrared heaters. If you want to cover yourself, your furniture and accessories, it is worth choosing side Shutters, ZIP blinds or glazing. You will gain a functional space to spend time at any time of the day or even year.

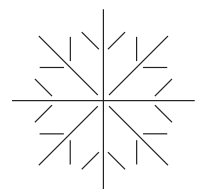
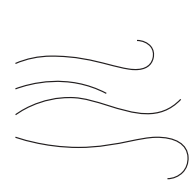
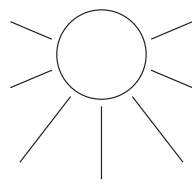
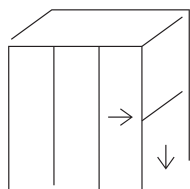

## Carport mit Photovoltaikanlage

### Carport with photovoltaic panels

Ein festes Dach bietet Ihnen die Möglichkeit, Photovoltaik-Module zu installieren und den daraus entstandenen Strom zum Betreiben von Haushaltsgeräten oder zum Aufladen eines Elektroautos zu nutzen.

The fixed roof will provide the opportunity for the installation of photovoltaic panels and the use of the resulting electricity to power household appliances or to charge an electric car.



**Dach mit Photovoltaikanlage**

Roof with photovoltaic panels



**Dach ohne Photovoltaikanlage**

Roof without photovoltaic panels

## Unterer Stoff (Option)

### Bottom roof - fabric (option)

Optional können Sie einen Unterstoff bestellen, der das von unten sichtbare Blech abdeckt. Die Unterseite des Daches besteht dann aus ästhetischem Stoff mit Balken, in denen LED-Strip Beleuchtung montiert werden kann.

As an additional option, a bottom roof can be ordered to cover the exposed roof sheet visible from below. The underside of the roof is then made of an aesthetically elegant fabric with beams in which LED Strip lights can be fitted.



**Unterer Stoffdach**

Bottom roof with the fabric



**Dach ohne Stoff**

Bottom roof without the fabric

# Bildergalerie

Photo  
gallery

---

Tarasola  
Carport

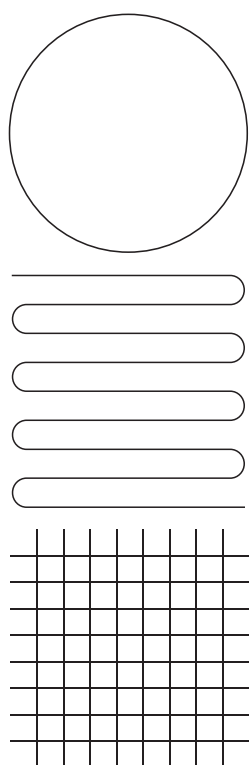





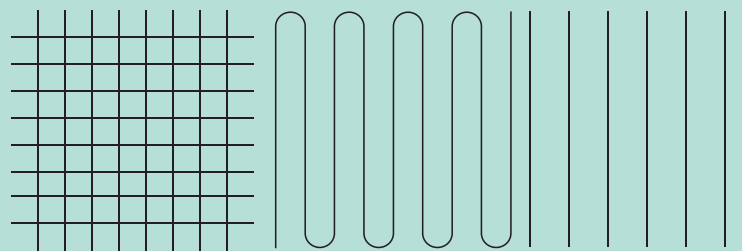
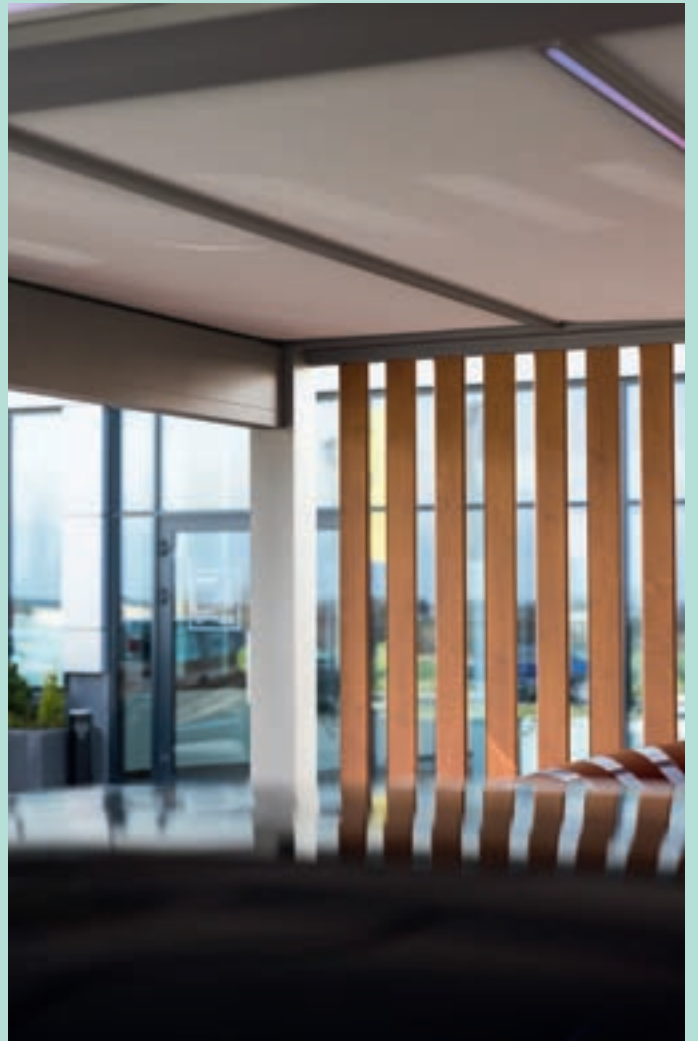













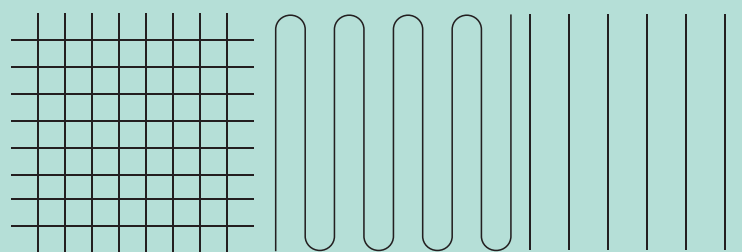



---

## Tarasola Fix



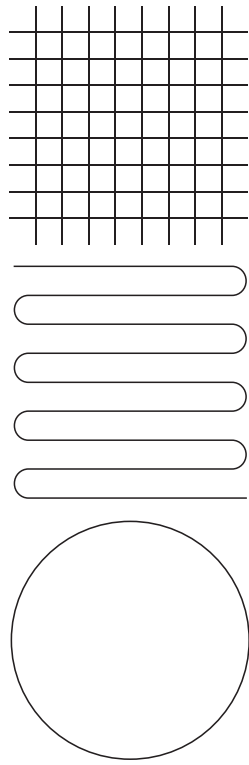



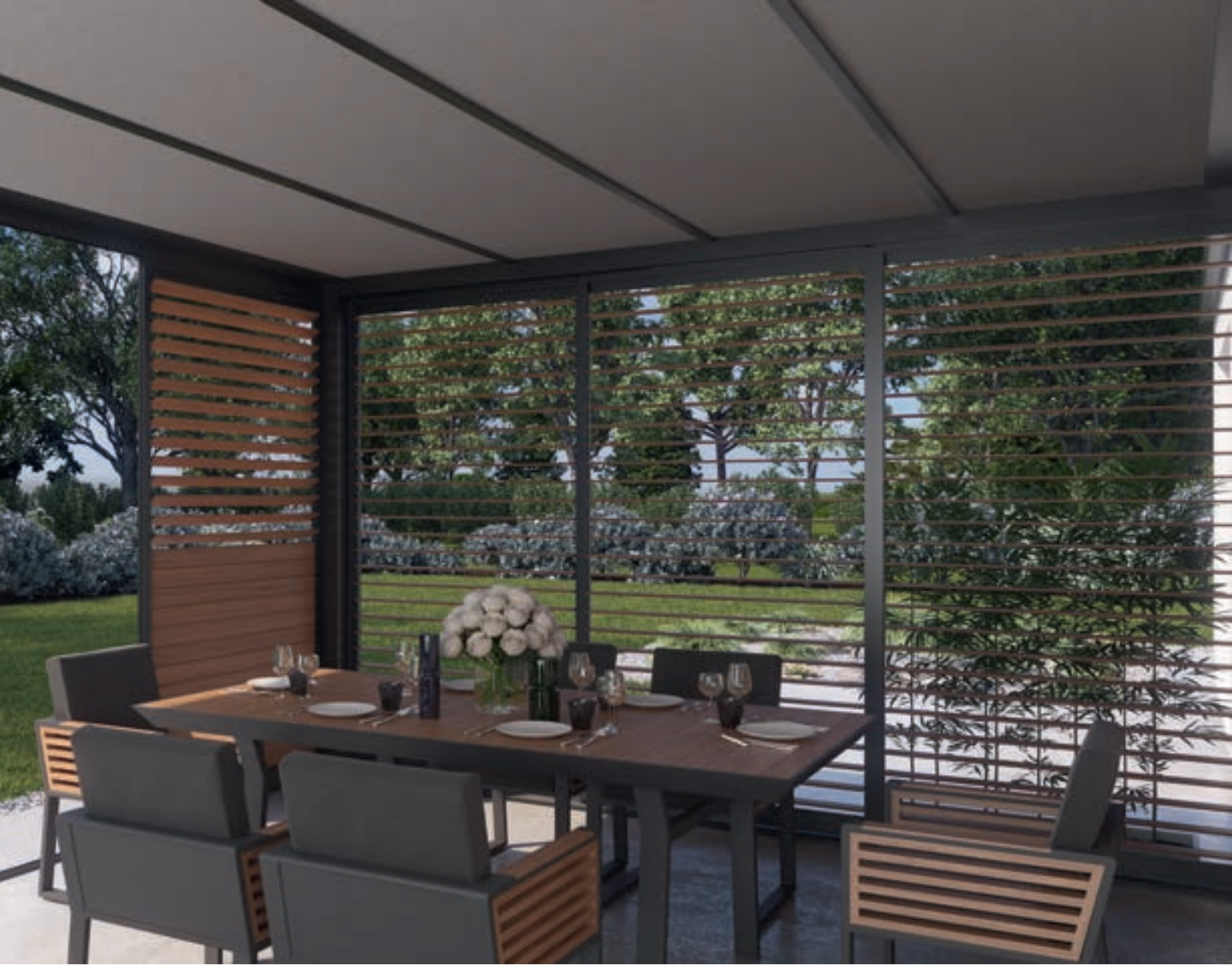





# Haupteigenschaften

## Key features



DE

Konstruktion aus pulverlackiertem extrudiertem **Aluminium**, Dach aus dem **Trapezblech**

---

**Entwässerungssystem** im Standard

---

Möglichkeit der Ausstattung des Carports mit der **Photovoltaikanlage** auf dem Dach

---

**Modulare** Anschlussmöglichkeit

---

Maximale Windlast **120 km/h**

---

Schneelast widerstandsfähig **72-300 kg/m<sup>2</sup>**

EN

**Aluminum** construction, **trapezoidal sheet metal** roof

---

Integrated, **water drainage system**

---

Possibility of mounting **photovoltaic panels** to the roof

---

Option of **modular** connection

---

Maximum wind resistance **120 km/h**

---

Resistance to snow load **72-300 kg/m<sup>2</sup>**

# Querschnitten | Cross-sections

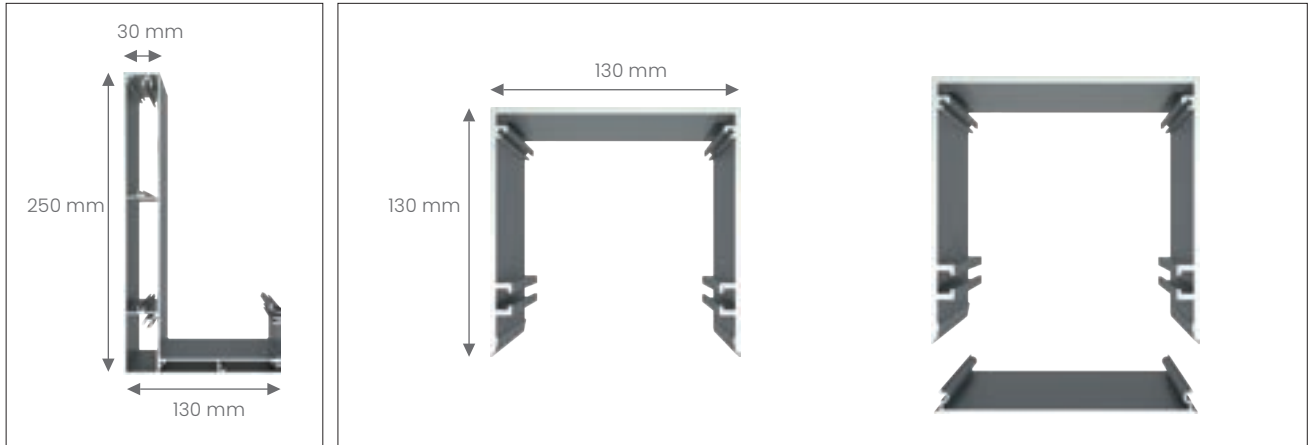

**Durschnitt des Konstruktionsprofils**  
Construction profile

**Pfosten mit Blindleiste**  
Openable supporting profile

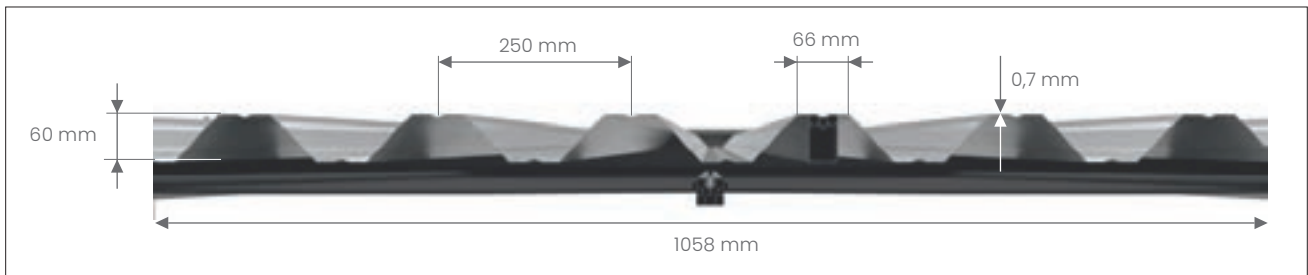

**Querschnitt des Trapezbleches T60P (mm) | Cross-section through trapezoidal sheet T60P (mm)**

# Entwässerungssystem

## Water drainage system





# Moduls und maximale Abmessung

## Models and maximum dimensions





### Einzelcarport | One-station Carport



PAVILON	GARDENA	TENDE
		
<p>mit versetzten Pfosten   With gate</p> 	<p>mit versetzten Pfosten   With gate</p> 	

## Doppelcarport | Two-stations Carport

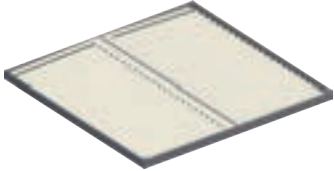

PAVILON	GARDENA	TENDE
		
<p>mit versetzten Pfosten   With gate</p> 	<p>mit versetzten Pfosten   With gate</p> 	

# Einzelcarport Modularität | One-station Modular Carport



PAVILON	GARDENA	TENDE

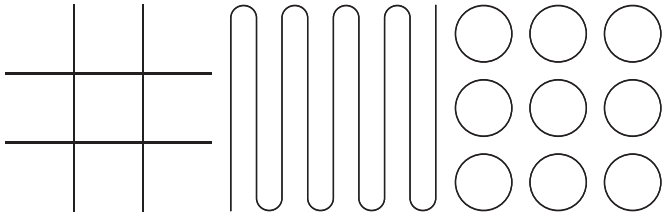



# JUICEBOX PRO AUTOLADESTATION

Car Charging Station JUICEBOX PRO



DE

**JuiceBox Pro** Erhältlich in 22 kW, 32 A, 3-phasig fazowa. Die verfügt über eine Funktion Demand Limitation Pro für die Aufladung mit maximal verfügbarer Leistung, ohne die Leistung zu überschreiten.

EN

**JuiceBox Pro** Available in 22 kW, 32A, and 3-phase power level. It has a Demand Limitation Pro feature that allows charging at the maximum available power without exceeding it.

# Photovoltaikanlage

## Photovoltaic panels



DE

Tarasola Carport ist ein maßgefertigtes Dach. Photovoltaik-Module, die ihre festen Abmessungen haben, setzen bestimmte Rahmen, aber das Trapezblechdach unter ihnen ermöglicht es Ihnen, die Größe des Daches an die Bedürfnisse des Investors anzupassen. Abhängig von der gewählten Dimension der Konstruktion werden geeignete PV-Modulenpakete ausgewählt.

EN

Tarasola Carport is a tailor-made roof. The photovoltaic panels, which have their own fixed dimensions, define a specific framework, but the trapezoidal sheet metal roof underneath makes it possible to adapt the size of the Carport to the investor's needs. Depending on the chosen dimensions of the structure, the appropriate panel packages are selected.

## Beispielhafte Pakete | Set of examples

### PAKET 1 | PACKAGE 1

**Einzelcarp** | One-station Carport

Breite   Width	400 cm
Auskragung   Projection	590 cm
Photovoltaikmodul   Panels	10 Stück   pcs. TIGER NEO (TYP N 54HL4-B 400-420 W)
Gesamtleistung   Total output	4200 W

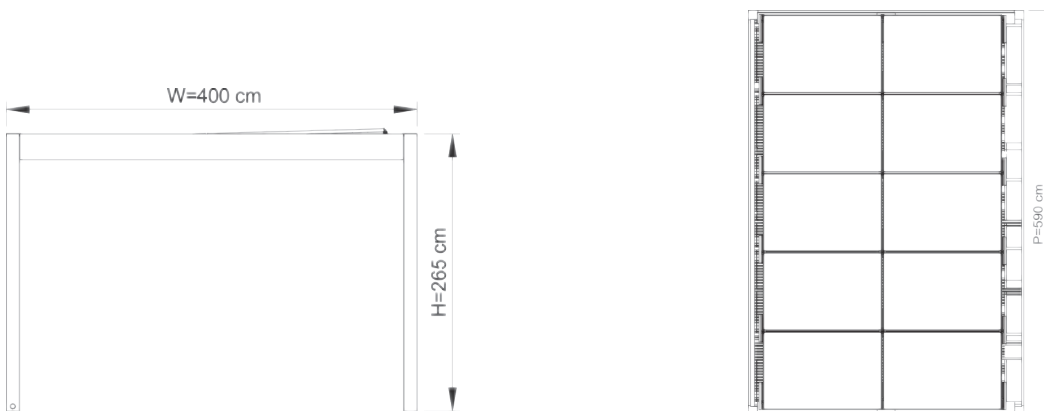

### PAKET 2 | PACKAGE 2

**Doppelcarport** | Two-stations Carport

Breite   Width	530-600 cm
Auskragung   Projection	540-590 cm
Photovoltaikmodul   Panels	12 Stück   pcs. TIGER NEO (TYP N 54HL4-B 400-420 W)
Gesamtleistung   Total output	5040 W

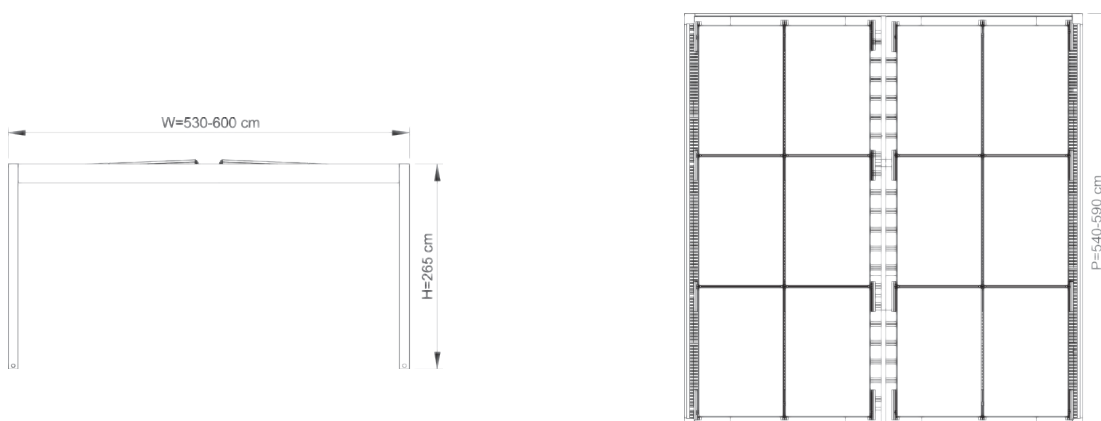

# Seitliche Ausstattung

## Side development



# Zubehör

## Accessories

LED Beleuchtung

LED Lighting

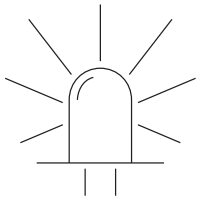

Unterer Stoffdach | Bottom roof with the fabric

LED Spot



LED Strip



Dach ohne Stoff | Bottom roof without the fabric

LED Strip



Heizstrahler

Infrared heater

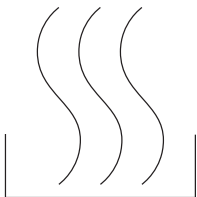

# Farbpalette | Colour Range

## Konstruktion | Construction

### STANDARD



9010 ST

Creme-Weiß

Colour Creamwhite



9007 ST

Grau Aluminium

Grey Aluminium

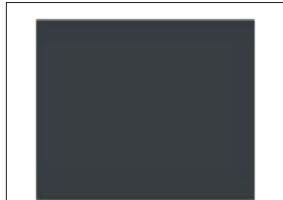

7016 ST

Anthrazit-Metallic

Anthracite Metallic

### SONSTIGE FARBEN | ADDITIONAL



Beliebige RAL

Any RAL

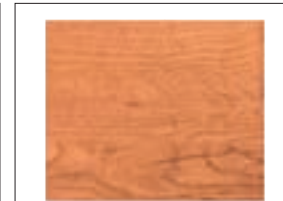

Holzähnlicher Lack

Wood-like varnish

## Blech | Trapezoidal sheet

### STANDARD



9010

Creme-Weiß

Colour Creamwhite



9007

Grau Aluminium

Grey Aluminium

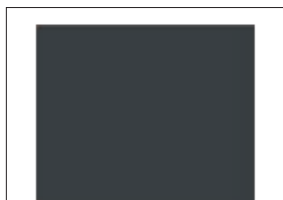

7016

Anthrazit-Metallic

Anthracite Metallic

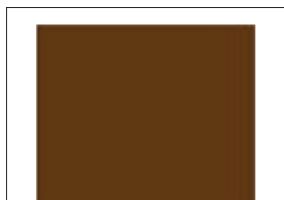

8004

Braun

Brown

### SONSTIGE FARBEN | ADDITIONAL



Beliebige RAL



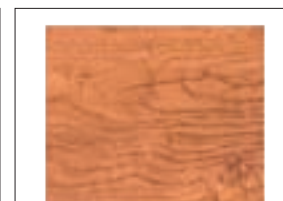







Any RAL



Holzähnlicher Lack

Wood-like varnish

**Opatex – Unterer Stoffdach** | Opatex Fabric – bottom roof

	<p>Weiß/Weiß White/White</p>		<p>Anthrazit/Creme Anthracite/Cream</p>
	<p>Grau/Hellgrau Light grey</p>		<p>Graubraun/Creme Taupe/Cream</p>
	<p>Creme/Creme Cream/Cream</p>		<p>Grün/Creme Green/Cream</p>
	<p>Grau/Creme Grey/Cream</p>		<p>Anthrazit/Anthrazit Anthracite/Anthracite</p>
	<p>Bordeauxrot/Creme Bordeaux/Cream</p>		<p>Schwarz/Schwarz Black/Black</p>

**SONSTIGE STOFFE** | ADDITIONAL



Veozip | Serge 600 / Copaco / Aeroflex | Soltis W 96 | Serge 600 SOLAR



# Zertifikate | Certificates

Design von Aluminiumkonstruktionen	Design of aluminium structures	EUROCODE 9: EN 1999
Trapezblech	Trapezoidal sheet metal	PN-EN 14782:2008
Außenbeschattung. Betriebs- und Sicherheitsanforderungen.	External blinds. Performance requirements including safety	PN-EN 13561 + A1/2010
Verordnung zur Festlegung harmonisierter Bedingungen für die Vermarktung von Bauprodukten	Regulation of the construction products	CPR 305/2011
LED-Module für Allgemeinbeleuchtung: Sicherheitsanforderungen	LED lighting	EN 62031 :2008
Pulverbeschichtung	Powder-coating	QUALICOAT
Maximale Windbeständigkeit	Maximum wind resistance	120 km/h
Schneelastwiderstandsfähigkeit	Snow resistance	72-300 kg/m2

# Auszeichnungen | Awards

 <p>2011-2021 KONSUMENTENFÜHRER DER DEKADE</p> <hr/> <p>Consumer Leader of the Decade</p>	 <p>2020 INNOWATORY WPROST INNOVATION IN DER DESIGN - KATEGORIE</p> <hr/> <p>Innovation in the DESIGN category</p>	 <p>2020 GESCHÄFTSGAZELLE</p> <hr/> <p>Business Gazelles</p>
----------------------------------------------------------------------------------------------------------------------------------------------------------------------------------	-------------------------------------------------------------------------------------------------------------------------------------------------------------------------------------------------------------------	-------------------------------------------------------------------------------------------------------------------------------------------------------



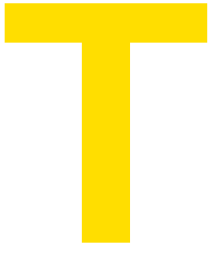

**Tarasola.com**

